

complementi



PRESOTTO
ITALIA



complementi

	pag.
Sideboard H.584	16 _ 23 _
InclinART philosophy	31 _
Sideboard_inclinART H.584	37 _
Sideboard H.776	61 _
Sideboard_Mood _H.1160 _H.1736	69 _
Tables, coffee tables, chairs, mirrors, shelves	85 _
Size	145 _
Index	153 _



ecomalta®



cor-ten





stone



rovere "vissuto"

"Aged" oak
Eiche "im Antik-Look"
Chêne "vécu"

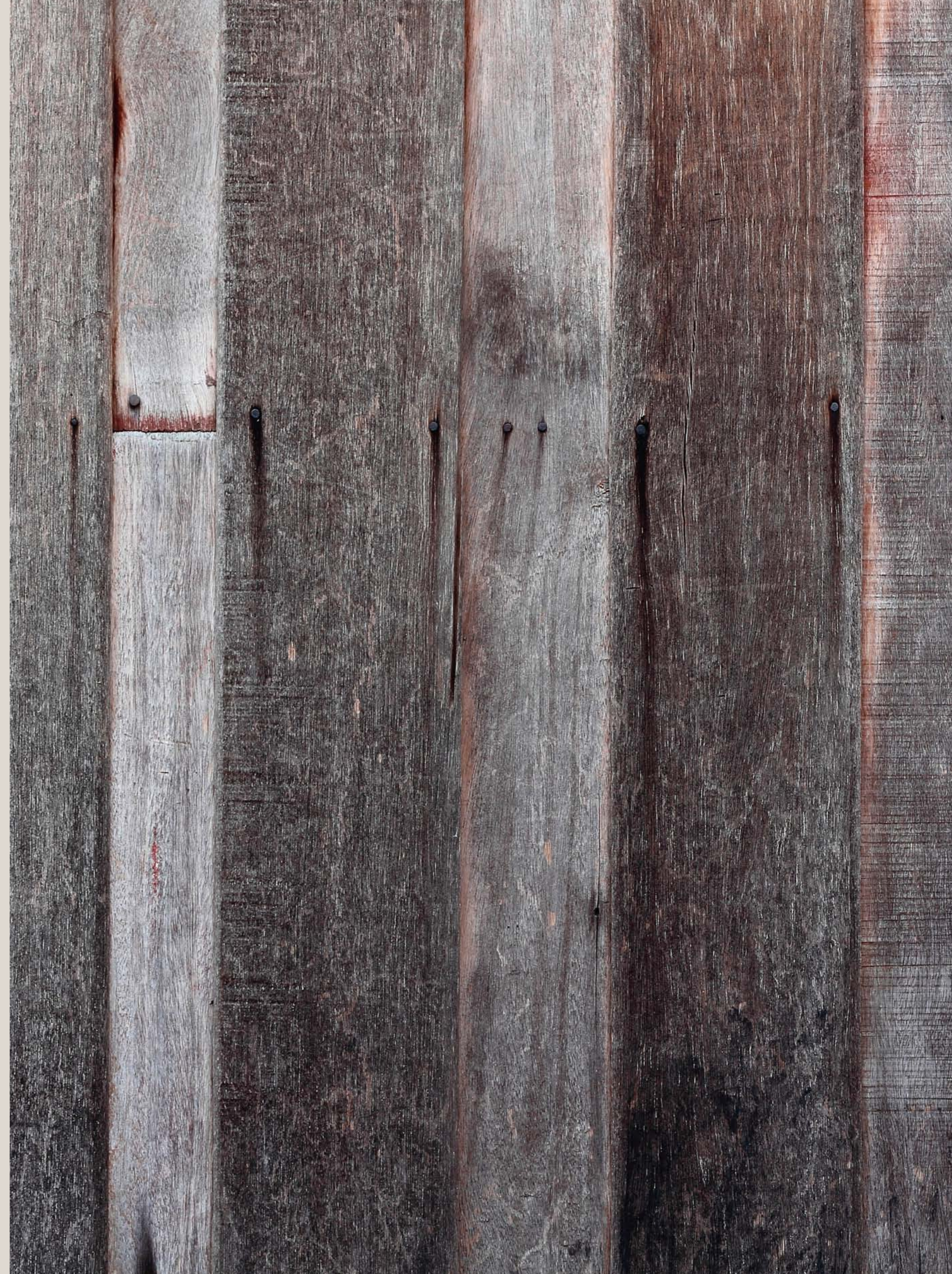



vintage







Recupero della memoria storica. Immagini del passato vengono impresse su ante impiallacciate con abete di forte spessore. Realizzate con una particolare e innovativa tecnica che mette assieme il sapere digitale e la finitura artigianale, arricchendo l'ambiente domestico con il fascino del "vintage".
 The revival of memories of bygone days. Images from the past are printed on the doors veneered with thick fir wood, using a special, innovative technique that combines digital know-how with handcraft finishes to enrich the home with vintage charm.
 Die Wiedererlangung der historischen Erinnerung. Bilder der Vergangenheit werden auf Türen mit besonders starkem Tannenholz furnier gedruckt. Die besondere und innovative Herstellungstechnik vereint digitales Wissen und handwerkliche Kunstfertigkeit und schenkt dem Wohnambiente einen faszinierenden "Vintage-Stil".
 Récupération de la mémoire historique. Les images du passé sont imprimées sur des portes plaquées en sapin de forte épaisseur. Réalisées avec une technique particulière et innovante qui allie le savoir numérique à la finition artisanale, en enrichissant l'espace domestique avec le charme du "vintage".

A pagina precedente: Madia H.584 in color wood grigio piombo con anta vintage "union jack". Con basamento metacrilato trasparente l'altezza totale diventa di 760mm.
 On the preceding page: Sideboard H.584 in grigio piombo color wood with "union jack" vintage door. With the addition of the transparent methacrylate support the total height becomes 760mm.
 Auf der vorhergehenden Seite: Sideboard H.584 in Color wood grigio piombo mit Tür vintage "union jack". Mit Untergestell aus transparentem Methacrylat beträgt die Gesamthöhe 760mm.
 Page précédente: Buffet H.584 en color wood grigio piombo avec porte vintage "union jack". Avec le piètement en méthacrylate transparent, sa hauteur totale sera de 760mm.

A lato: Madia H.584 in laccato opaco beige cappuccino con anta vintage "espresso". Il basamento metacrilato trasparente porta l'altezza totale a 760mm, luce a led optional.
 To the side: Sideboard H.584 in beige cappuccino matt lacquer with "espresso" vintage door. With the addition of the transparent methacrylate support the total height becomes 760mm. Optional led lighting.
 Seitlich: Sideboard H.584 in Lack matt beige cappuccino mit Tür vintage "espresso". Das Untergestell aus transparentem Methacrylat führt zu einer Gesamthöhe von 760mm, LED-Beleuchtung als Option.
 Ci-contre: Buffet H.584 laqué beige cappuccino mat avec porte vintage "espresso". Grâce au piètement en méthacrylate transparent, sa hauteur totale est de 760mm. Éclairage à led optionnel.



Madia H.584 in rovere "vissuto" basalto con anta vintage "10 lire".
 Il basamento metacrilato trasparente porta l'altezza totale a 760mm,
 luce a led optional. L'anta ribalta è in pietra Galaxy.
 Sideboard H.584 in "aged" basalto oak with "10 lire" vintage door.
 With the addition of the transparent methacrylate support the total height
 becomes 760mm. Optional led lighting. The bottom-hung door is in
 Galaxy stone.
 Sideboard H.584 in Eiche "im Antik-Look" basalto mit Tür vintage
 "10 lire". Das Untergestell aus transparentem Methacrylat führt zu einer
 Gesamthöhe von 760mm, LED-Beleuchtung als Option.
 Die Klapptür ist in Stein Galaxy ausgeführt.
 Buffet H.584 en chêne "vécu" basalto avec porte vintage "10 lire". Grâce au
 piètement en méthacrylate transparent, sa hauteur totale est de 760mm.
 Éclairage à led optionnel. La porte abattante est en pierre Galaxy.





Sideboard_H.584

Madia H.584 in laccato opaco beige seta con anta vintage "espresso", top e cassetti in rovere "vissuto" tabacco. Il basamento metacrilato trasparente porta l'altezza totale a 760mm, luce a led optional.

Sideboard H.584 in matt beige seta lacquer with "espresso" vintage door, top and drawers in "aged" tabacco oak. With the addition of the transparent methacrylate support the total height becomes 760mm. Optional led lighting.

Sideboard H.584 in Lack matt beige seta mit Tür vintage "espresso", Abdeckplatte und Schubladen in Eiche "im Antik-Look" tabacco. Das Untergestell aus transparentem Methacrylat führt zu einer Gesamthöhe von 760mm, LED-Beleuchtung als Option.

Buffet H.584 laqué beige seta mat avec porte vintage "espresso", plateau et tiroirs en chêne "vécu" tabacco. Grâce au piètement en méthacrylate transparent, sa hauteur totale est de 760mm. Éclairage à led optionnel.





Il top in rovere "vissuto" tabacco rientra rispetto al fianco in perfetto allineamento con l'anta.
The top in "aged" tabacco oak recedes slightly from the side panel, becoming perfectly aligned with the door.
Die Abdeckplatte in Eiche "im Antik-Look" tabacco weicht von der Seitenwand zurück und bildet so einen perfekten Abschluss mit der Tür.
Le plateau en chêne "vécu" tabacco est en retrait par rapport au côté s'alignant parfaitement sur la porte.



Madia H.584 in laccato opaco beige seta,
top e cassetti in rovere "vissuto" tabacco.
Sideboard H.584 in matt beige seta lacquer,
top and drawers in "aged" tabacco oak.
Sideboard H. 584 in Lack matt beige seta, Abdeckplatte
und Schubladen in Eiche "im Antik-Look" tabacco.
Buffet H.584 laqué beige seta mat, plateau
et tiroirs en chêne "vécu" tabacco.



Union Jack



Stars and stripes



Espresso



10 Lire

inclinART

nuove prospettive abitative

Design: Pierangelo Sciuto

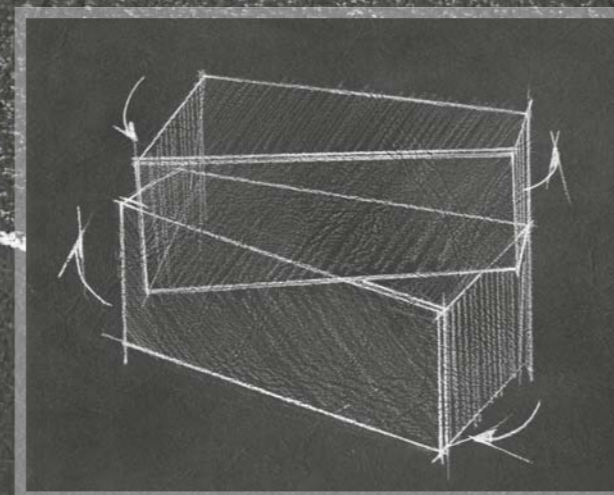
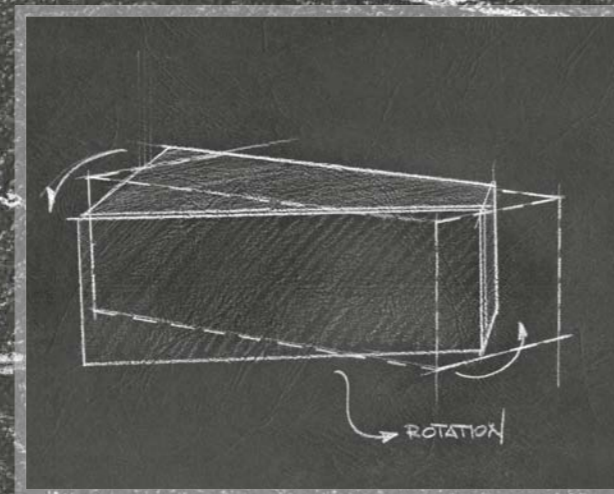
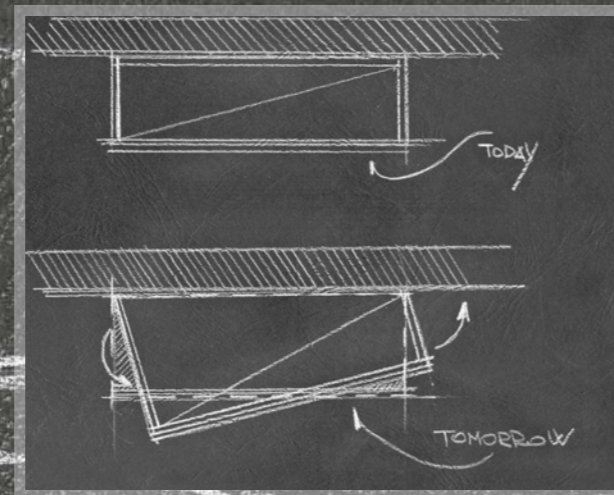

Dopo la tendenza decostruttivista dove ho immaginato e generato le più varie e libere composizioni, ho proseguito nella riscrittura degli spazi secondo logiche di stile e di funzionalità volti a soddisfare il mio desiderio di soluzioni rivitalizzate e che escano dagli schemi omologati. Nasce così: inclinART, un sistema d'arredo componibile esclusivo che cambia le regole di base del mobile.

Il suo asse diventa variabile e con esso si modifica la profondità dei piani: il risultato è una nuova percezione dei volumi, i piani non sono più paralleli alla parete, ma si inclinano davanti all'osservatore che può godere così di nuove "prospettive abitative" che nascono dai diversi gradi d'inclinazione.

inclinART:
New living prospects

Pursuant to the deconstructivism trend in which I imagined and generated many varied and independent arrangements, I continued to rewrite spaces according to stylistic and functional logics aimed at satisfying my desire for revitalised solutions that elude commonplace layouts. This is how inclinART was born, an exclusive modular furniture system that changes the basic rules that govern furniture. Its axis becomes variable and the depths of the tops change with it, resulting in a new way of perceiving volumes: the tops are no longer parallel with the wall but slant towards the onlooker who can enjoy the new perspectives that result from the differing degrees of inclination.

inclinART:
Neue Wohnperspektiven

Nach der Phase des Dekonstruktivismus, während der ich die unterschiedlichsten und freiesten Kompositionen entwarf und

realisierte, setzte ich meine Arbeit mit der Neufassung der Räume anhand stilistischer und zweckmäßiger Logiken fort, die meinen Vorstellungen von revitalisierten und von einheitlichen Schemen weit entfernten Lösungen entsprachen.

Daraus entsteht: inclinART, ein exklusives anbaufähiges Einrichtungssystem, das die Grundregeln des Möbels verändert. Seine Achse wird variabel und damit ändert sich auch die Tiefe der Platten: Das Ergebnis ist eine neue Wahrnehmung der Elemente, die geraden Flächen verlaufen nicht mehr parallel zur Wand, sondern neigen sich vor dem Auge des Betrachters, der dadurch in den Genuss von neuen "Wohnperspektiven" kommt, die aus unterschiedlich starken Abschrägungen entstehen.

inclinART:
De nouvelles perspectives d'ameublement

Après la tendance à la déconstruction où j'ai imaginé et où j'ai créé les compositions les plus diverses et les plus libres, j'ai continué en réécrivant des espaces selon des logiques de style et de fonctionnalité visant à satisfaire mon souhait de solutions revitalisées et sortant des contraintes homologuées.

C'est ainsi qu'est né inclinART, un système d'ameublement, composable et unique, changeant les règles de base du meuble. Son axe devient variable et la profondeur des plans se modifie: le résultat est une nouvelle perception des volumes. Les plans ne sont plus parallèles au mur, mais ils s'inclinent devant l'observateur qui peut profiter ainsi de nouvelles "perspectives d'ameublement" dérivant des différents degrés d'inclinaison.



#295

Base, libreria e struttura elementi pensili in color wood bianco candido.
Base unit, bookcase and wall unit structures in bianco candido color wood.
Unterschrank, Bücherregal und Struktur der Wandelemente in Color wood bianco candido.
Élément bas, bibliothèque et structure des éléments suspendus en color wood bianco candido.





Sideboard _inclinART H.584

inclinART, un sistema d'arredo componibile esclusivo che cambia le regole di base del mobile. Madia H.584 sospesa inclinART con 3 vani, ognuno è composto da due ante asimmetriche. Struttura e top in rovere "vissuto" basalto con ante in rovere "vissuto" basalto, pietra Galaxy, ecomalta® grigio polvere e laccato opaco rosso cina.

inclinART, an exclusive modular furniture system that changes the basic rules that govern furniture. Wall-hung inclinART sideboard H.584 with 3 compartments, each of which is composed of two unsymmetrical doors. Structure and top in "aged" basalto oak with doors in: "aged" basalto oak, Galaxy stone, grigio polvere ecomalta® and matt rosso cina lacquer.

inclinART, ein exklusives anbaufähiges Einrichtungssystem, das die Grundregeln des Möbels verändert. Hänge-Sideboard H.584 inclinART mit 3 Abteilen, jedes besitzt zwei asymmetrische Türen. Struktur und Abdeckplatte in Eiche "im Antik-Look" basalto mit Türen in Eiche "im Antik-Look" basalto, Stein Galaxy, Ecomalta® grigio polvere und Lack matt rosso cina.

inclinART, un système d'ameublement, composable et unique, changeant les règles de base du meuble. Buffet H.584 suspendu inclinART avec 3 compartiments, chacun desquels est doté de deux portes asymétriques. Structure et plateau en chêne "vécu" basalto avec portes en: chêne "vécu" basalto, pierre Galaxy, ecomalta® grigio polvere et laqué rosso cina mat.



Madie H.584 sospese inclinART con 3 vani, ognuno è composto da due ante asimmetriche.

Struttura e top in ecomalta® grigio polvere con ante: ecomalta® grigio polvere, rovere "vissuto" basalto e cor-ten.

Struttura e top in rovere "vissuto" tabacco con ante: rovere "vissuto" tabacco, pietra Black slate, ecomalta® grigio polvere, laccato opaco verde ossido.

Wall-hung inclinART sideboards H.584 with 3 compartments, each of which is composed of two unsymmetrical doors.

Structure and top in grigio polvere ecomalta® with doors in: grigio polvere ecomalta®, "aged" basalto oak and cor-ten.

Structure and top in "aged" tabacco oak with doors in: "aged" tabacco oak, Black slate stone, grigio polvere ecomalta® and matt verde ossido lacquer.

Hänge-Sideboards H. 584 inclinART mit 3 Abteilen, jedes besitzt zwei asymmetrische Türen.

Struktur und Abdeckplatte in Ecomalta® grigio polvere mit Türen: Ecomalta® grigio polvere, Eiche "im Antik-Look" basalto und Cor-ten.

Struktur und Abdeckplatte in Eiche "im Antik-Look" tabacco mit Türen: Eiche "im Antik-Look" tabacco, Stein Black slate, Ecomalta® grigio polvere, Lack matt verde ossido.

Buffets H.584 suspendus inclinART avec 3 compartiments, chacun desquels est doté de deux portes asymétriques.

Structure et plateau en ecomalta® grigio polvere avec portes en: ecomalta® grigio polvere, chêne "vécu" basalto et cor-ten.

Structure et plateau en chêne "vécu" tabacco avec portes en: chêne "vécu" tabacco, pierre Black slate, ecomalta® grigio polvere, laqué verde ossido mat.



Madia H.584 sospesa inclinART con 4 vani ognuno è composto da due ante asimmetriche. Struttura, top e ante laccato opaco bianco candido.

Wall-hung inclinART sideboard H.584 with 4 compartments, each of which is composed of two unsymmetrical doors. Matt bianco candido lacquered structure, top and doors.

Hänge-Sideboard H. 584 inclinART mit 4 Abteilen, jedes besitzt zwei asymmetrische Türen. Struktur, Abdeckplatte und Türen in Lack matt bianco candido.

Buffet H.584 suspendu inclinART avec 4 compartiments, chacun desquels est doté de deux portes asymétriques. Structure, plateau et portes laqués bianco candido mat.





Sideboard #300 inclinART

inclinART, un sistema d'arredo componibile esclusivo che cambia le regole di base del mobile. Base sospesa in rovere "vissuto" creola, elementi pensili inclinART in laccato opaco crema. Tavolo allungabile Oplà in laccato opaco crema.

inclinART, an exclusive modular furniture system that changes the basic rules that govern furniture.

Wall-hung base unit in "aged" creola oak, inclinART wall units in matt crema lacquer. Extending Oplà table in matt crema lacquer.

inclinART, ein exklusives anbaufähiges Einrichtungssystem, das die Grundregeln des Möbels verändert.

Hängeunterschrank in Eiche "im Antik-Look" creola, Wandelemente inclinART in Lack matt crema. Ausziehbarer Tisch Oplà in Lack matt crema.

inclinART, un système d'ameublement, composable et unique, changeant les règles de base du meuble. Élément bas suspendu en chêne "vécu" creola, éléments suspendus inclinART laqués crema mat. Table à rallonges Oplà laquée crema mat.



La base è dotata di cassettone con cassetto interno.
The base unit is provided with a jumbo drawer containing a small interior drawer.
Der Unterschrank ist mit einem Schubkasten mit Innenschublade ausgestattet.
L'élément bas est doté d'un grand tiroir avec tiroir intérieur.



Base ed elementi pensili in laccato opaco beige seta con anta vintage "union jack".
Base units in matt beige seta lacquer with "union jack" vintage door.
Unterschrank und Wandelemente in Lack matt beige seta mit Tür vintage "union jack".
Élément bas et éléments suspendus laqués beige seta mat avec porte vintage "union jack".



#301

Base sospesa in rovere "vissuto" basalto, elementi pensili inclinART in ecomalta® grigio polvere.
Wall-hung base unit in "aged" basalto oak, inclinART wall units in grigio polvere ecomalta®.
Hängeunterschrank in Eiche "im Antik-Look" basalto, Wandelemente inclinART in Ecomalta® grigio polvere.
Élément bas suspendu en chêne "vécu" basalto, éléments suspendus inclinART en ecomalta® grigio polvere.



#310

Base sospesa ed elementi pensili in laccato opaco bianco candido.
Wall-hung base unit and wall unit in matt bianco candido lacquer.
Hängeunterschrank und Wandelemente in Lack matt bianco candido.
Élément bas et éléments suspendus laqués bianco candido mat.

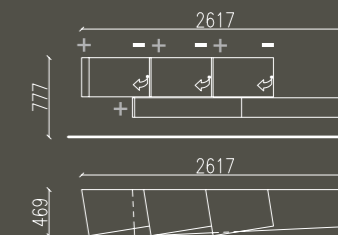

#303

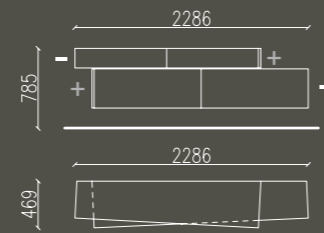

Base ed elemento pensile in laccato lucido bianco candido. La base ha i frontali in pietra patchwork Silver Shine. La particolare lavorazione artigianale dei frontali in pietra patchwork e la sua superficie ruvida e irregolare rendono ogni anta un pezzo unico e irripetibile.

Base unit and wall unit in gloss bianco candido lacquer. The base unit has patchwork Silver Shine stone fronts. The special handicraft workmanship of the patchwork stone fronts and their rough and uneven surfaces turn every door into a unique and unrepeatable item.

Unterschrank und Wandelement in Lack Hochglanz bianco candido. Der Unterschrank besitzt Fronten in Stein patchwork Silver Shine. Die besondere handwerkliche Bearbeitung der Fronten in Stein patchwork Silver Shine und die raue und unregelmäßige Oberfläche machen aus jeder Tür ein unnachahmliches Einzelstück.

Élément bas et élément suspendu laqués blancs candido brillant. Les façades de l'élément bas sont en pierre patchwork Silver Shine. La réalisation artisanale particulière des façades en pierre patchwork offrant une surface rugueuse et irrégulière donne à chaque porte un aspect unique qui ne se répète jamais.



#304

Base ed elementi pensili in ecomalta® beige seta con anta vintage "union jack".
Base and wall units in ecomalta® beige seta with "union jack" vintage door.
Unterschrank und Wandelemente in ecomalta® beige seta mit Tür vintage "union jack".
Élément bas et éléments suspendus en ecomalta® beige seta avec porte vintage "union jack".

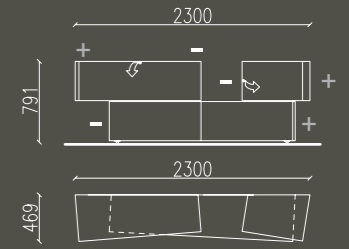

Sideboard H.776

In primo piano: Madia H.776 in laccato lucido beige cappuccino con ante in cor-ten. La particolare peculiarità della superficie ruvida e irregolare della lamina in cor-ten rende ogni anta un pezzo unico e irripetibile. Sullo sfondo: Madia H.776 in laccato opaco beige cappuccino con cassetti e ante in rovere "vissuto" tabacco.

In the foreground: Sideboard H.776 in gloss beige cappuccino lacquer with cor-ten doors. The original, rough, uneven surface of the sheets of cor-ten turns every door into a unique and unrepeatable item. In the background: Sideboard H.776 in matt beige cappuccino lacquer with drawers and doors in "aged" tobacco oak.

Im Vordergrund: Sideboard H.776 in Lack Hochglanz beige cappuccino mit Türen in Cor-ten. Die Besonderheit der rauen und unregelmäßigen Oberfläche des Stahlblechs Cor-ten macht aus jeder Tür ein unnachahmliches Einzelstück. Im Hintergrund: Sideboard H.776 in Lack matt beige cappuccino mit Schubladen und Türen in Eiche "im Antik-Look" tabacco.

Au premier plan: Buffet H.776 laqué beige cappuccino brillant avec portes en cor-ten. La particularité de la surface rugueuse et irrégulière de la feuille en cor-ten fait de chaque porte une pièce unique qui ne se répète jamais. Dans le fond: Buffet H.776 laqué beige cappuccino mat avec tiroirs et portes en chêne "vécu" tabacco.







Madia H.776 in laccato opaco verde oceano con ante in pietra Galaxy; a fianco madia H.776 in rovere "vissuto" basalto con cassetti e ante in ecomalta® grigio polvere. Sideboard H.776 in matt verde oceano lacquer with Galaxy stone doors; to the side, sideboard H.776 in "aged" basalto oak with grigio polvere ecomalta® drawers and doors.

Sideboard H.776 in Lack matt verde oceano mit Türen in Stein Galaxy; daneben Sideboard H.776 in Eiche "im Antik-Look" basalto mit Schubladen und Türen in Ecomalta® grigio polvere.

Buffet H.776 laqué verde oceano mat avec portes en pierre Galaxy; à côté, buffet H.776 en chêne "vécu" basalto avec tiroirs et portes en ecomalta® grigio polvere.

I vani delle madie sono attrezzabili con cassetto interno in alluminio con fondo in vetro e con cassetto in alluminio porta bottiglie.

The compartments of the sideboards can be fitted with an interior drawer in aluminium with a glass bottom panel and a drawer with an aluminium bottle rack.

Die Abteile der Sideboards können mit einer Innenschublade aus Aluminium mit Glasboden und einer Schublade aus Aluminium mit Flascheneinsatz ausgestattet werden.

Les compartiments des buffets peuvent être aménagés avec un tiroir intérieur en aluminium avec fond en verre et avec un tiroir range-bouteilles en aluminium.





Sideboard _mood _H. 1160 _H. 1736

**Madia Mood con 2 ante ad apertura
complanare in ecomalta® grigio
polvere, sullo sfondo madie H.1160
e tavolo Tailor.**

**Mood sideboard with 2 coplanar
sliding doors in grigio polvere
ecomalta®; sideboards H.1160 and
the Tailor table in the background.**

**Sideboard Mood mit 2 parallel
laufenden Türen in Ecomalta® grigio
polvere, im Hintergrund Sideboards
H.1160 und Tisch Tailor.**

**Buffet Mood avec 2 portes
coulissantes coplanaires en
ecomalta® grigio polvere.
Dans le fond et au centre,
buffets H.1160 et table Tailor.**



Madia Mood con 2 ante ad apertura complanare, in ecomalta® grigio polvere. Gli inserti maniglia possono essere in pietra, rovere "vissuto", laccato opaco e lucido, rovere grigio, color wood, ecomalta® e foglia oro e argento.

Mood sideboard with 2 coplanar sliding doors in grigio polvere ecomalta®. The handle inserts are available in stone, "aged" oak, matt or gloss lacquer, grey oak, color wood, ecomalta® and gold or silver leaf finishes.

Sideboard Mood mit 2 parallel laufenden Türen in Ecomalta® grigio polvere, die Griffeneinsätze können in Stein, in Eiche "im Antik-Look", in Lack matt und Hochglanz, in Eiche grigio, Color wood, Ecomalta® und Blattgold und Blattsilber: ausgeführt sein.

Buffet Mood avec 2 portes coulissantes coplanaires en ecomalta® grigio polvere. Les inserts poignée peuvent être déclinés dans les finitions suivantes: pierre, chêne "vécu", laqué mat ou brillant, chêne gris, color wood, ecomalta® et feuille d'or ou feuille d'argent.



Madia H.1160 in ecomalta® grigio polvere con ante in pietra Galaxy e laccato opaco verde oceano; a fianco madia H.1160 in rovere "vissuto" basalto con ante in ecomalta® grigio polvere. Il cassetto interno in alluminio con fondo in vetro consente la visibilità all'interno del vano.

Sideboard H.1160 in grigio polvere ecomalta® with Galaxy stone and matt verde oceano lacquered doors; to the side, sideboard H.1160 in "aged" basalto oak with grigio polvere ecomalta® doors. The interior aluminium drawer has a glass bottom panel that lets the inside of the compartment show through.

Sideboard H. 1160 in Ecomalta® grigio polvere mit Türen in Stein Galaxy und Lack matt verde oceano; daneben Sideboard H. 1160 in Eiche "im Antik-Look" basalto mit Türen in Ecomalta® grigio polvere. Die Innenschublade aus Aluminium mit Glasboden ermöglicht einen optimalen Blick auf den Innenraum.

Buffet H.1160 en ecomalta® grigio polvere avec portes en pierre Galaxy et laquées verde oceano mat. À côté, buffet H.1160 en chêne "vécu" basalto avec portes en ecomalta® grigio polvere. Le tiroir intérieur en aluminium avec fond en verre permet de voir l'intérieur du compartiment.





Madia H.1160 in ecomalta® beige seta con ante in rovere "vissuto" tabacco; a fianco madia H.1160 in laccato opaco beige seta con ante in pietra Galaxy e laccato opaco verde ossido. Il basamento in metallo è laccato opaco beige seta, porta l'altezza totale a 1336mm. È disponibile in 34 colori laccato opaco e in finitura cromo lucido.

Sideboard H.1160 in beige seta ecomalta® with "aged" tabacco oak doors; to the side, sideboard H.1160 in matt beige seta lacquer with Galaxy stone and matt verde ossido lacquered doors. The metal support is in matt beige seta lacquer and raises the sideboard to a total height of 1336mm. It is available in 34 matt lacquer colours and in the polished chrome finish.

Sideboard H.1160 in Ecomalta® beige seta mit Türen in Eiche "im Antik-Look" tabacco; daneben Sideboard H.1160 in Lack matt beige seta mit Türen in Stein Galaxy und Lack matt verde ossido. Das Untergestell aus Metall in Lack matt beige seta führt zu einer Gesamthöhe von 1336mm. Es ist in 34 Farben in Lack matt und in Ausführung Chrom Hochglanz erhältlich.

Buffet H.1160 en ecomalta® beige seta avec portes en chêne "vécu" tabacco. À côté, buffet H.1160 laqué beige seta mat avec portes en pierre Galaxy et laquées verde ossido mat.

Le piètement en métal laqué beige seta mat permet au buffet d'atteindre une hauteur totale de 1336mm. Il existe en 34 coloris laqués mats ou en chrome brillant.

Dettaglio del vano composto da due ante asimmetriche.
Close-up view of the compartment composed of two unsymmetrical doors.
Detailansicht des Abteils hinter zwei asymmetrischen Türen.
Premier plan de l'élément doté de deux portes asymétriques.



Madia H.1160 in ecomalta® grigio polvere con ante in pietra Galaxy; a fianco madia H.1160 in rovere "vissuto" basalto, con ante sp.6mm e 20mm. Le ante con vetro trasparente sp.20mm sono composte da due fasce asimmetriche in legno e una centrale in vetro trasparente sp.6mm. Le fasce esterne in legno sono personalizzabili nelle finiture laccato opaco, lucido, color wood, rovere vissuto ed ecomalta®, nella foto la fascia è laccato opaco verde army.

Sideboard H.1160 in grigio polvere ecomalta® with Galaxy stone doors; to the side, sideboard H.1160 in "aged" basalto oak with 6mm and 20mm thick doors. The doors with 20mm thick transparent glass are composed of two unsymmetrical wooden strips and one central, 6mm thick, transparent glass strip. The outer wooden strips can be customised in matt, gloss, color wood, "aged" oak and ecomalta® finishes. In the photo the strip is in matt verde army lacquer.

Sideboard H. 1160 in Ecomalta® grigio polvere mit Türen in Stein Galaxy; daneben Sideboard H. 1160 in Eiche "im Antik-Look" basalto mit Türen St. 6 mm und 20 mm. Die Türen mit transparentem Glas St. 20 mm bestehen aus zwei asymmetrischen Seitenteilen aus Holz und einem mittleren Einsatz aus transparentem Glas St. 6 mm. Die Seitenteile aus Holz können in den Ausführungen Lack matt, Hochglanz, Color wood, Eiche "im Antik-Look" und Ecomalta® individuell gestaltet werden, auf dem Foto ist ein Seitenteil in Lack matt verde army ausgeführt.

Buffet H.1160 en ecomalta® grigio polvere avec portes en pierre Galaxy; à côté, buffet H.1160 en chêne "vécu" basalto avec portes ép. 6 mm et ép. 20 mm.

Les portes avec verre transparent sont réalisées avec deux bandeaux asymétriques en bois ép. 20 mm et un bandeau central en verre transparent ép. 6 mm. Les bandeaux extérieurs en bois peuvent être personnalisés dans les finitions suivantes: laqué mat, laqué brillant, color wood, chêne "vécu" et ecomalta®. Ci-contre, le bandeau est laqué verde army mat.

Sotto: Dettaglio delle ante sp.20mm con vetro trasparente sp.6mm.

Below: Close-up view of the 20mm thick doors with 6mm transparent glass.

Unten: Detailansicht der Türen St. 20 mm mit transparentem Glas 6 mm.

Ci-dessous: Premier plan des portes ép. 20 mm avec verre transparent ép. 6 mm.





Madia H.1736 in laccato opaco beige cappuccino con fasce laccato opaco beige seta, beige cappuccino e beige argilla; a fianco in laccato opaco verde oceano.
 Sideboard H.1736 in matt beige cappuccino lacquer with matt beige seta, beige cappuccino and beige argilla strips; adjacent sideboard in matt verde oceano lacquer.
 Sideboard H. 1736 in Lack matt beige cappuccino mit Seitenteilen in Lack matt beige seta, beige cappuccino und beige argilla; daneben in Lack matt verde oceano.
 Buffet H.1736 laqué beige cappuccino mat avec bandeaux laqués beige seta, beige cappuccino et beige argilla mat. À côté, buffet laqué verde oceano mat.

Le madie H.1160 sono in ecomalta® beige seta con ante in rovere "vissuto" tabacco; a fianco in rovere "vissuto" basalto con frontali in pietra Galaxy sp.6mm e laccato opaco verde oceano e rovere "vissuto" basalto sp.20mm.

The sideboards H.1160 are in beige seta ecomalta® with "aged" tabacco oak doors; to the side, they are in "aged" basalto oak with 6mm thick Galaxy stone fronts and in 20mm thick matt verde oceano lacquer and "aged" basalto oak.
 Die Sideboards H.1160 sind in Ecomalta® beige seta mit Türen in Eiche "im Antik-Look" tabacco ausgeführt; daneben in Eiche "im Antik-Look" basalto mit Fronten in Stein Galaxy St. 6 mm und in Lack matt verde oceano und Eiche "im Antik-Look" basalto St. 20 mm.

Les buffets H.1160 sont en ecomalta® beige seta avec portes en chêne "vécu" tabacco. À côté, buffet en chêne "vécu" basalto avec façades en pierre Galaxy ép. 6 mm, laquées verde oceano mat et en chêne "vécu" basalto ép. 20 mm.

Sotto: nella versione con ante sp.20mm il top rimane rientrante, formando una sporgenza omogenea con il fianco.

Below: in the version with 20mm thick doors, the top recedes from the front to create greater harmony with the protrusion of the side panel.

Unten: bei der Version mit Türen St. 20 mm ist die Abdeckplatte leicht zurückversetzt und bildet so einen gleichförmigen Vorsprung mit der Seitenwand.

Ci-dessous: dans la version avec portes ép. 20 mm, le plateau est en retrait et forme un débordement homogène avec le côté.



Madia H.1160 in rovere "vissuto" basalto con cassetti in laccato opaco beige seta; a fianco in laccato opaco beige seta con anta vintage "stars and stripes". Il basamento in metacrilato trasparente porta l'altezza totale a 1336mm.
Sideboard H.1160 in "aged" basalto oak with drawers in matt beige seta lacquer; adjacent to it, sideboard in matt beige seta lacquer with "stars and stripes" vintage door. The methacrylate support is transparent and raises the sideboard to a total height of 1336mm.
Sideboard H.1160 in Eiche "im Antik-Look" basalto mit Schubladen in Lack matt beige seta; daneben in Lack matt beige seta mit Tür vintage "stars and stripes". Das Untergestell aus transparentem Methacrylat führt zu einer Gesamthöhe von 1336 mm.
Buffet H.1160 en chêne "vécu" basalto avec tiroirs laqués beige seta mat. À côté, buffet laqués beige seta mat avec porte vintage "stars and stripes". Le piètement en méthacrylate transparent permet au buffet d'atteindre une hauteur totale de 1336 mm.





tables
coffee tables
chairs
mirrors
shelves

pag.

Tables

Tavoli, Tische, tables

87_ Tailor

95_ Oplà

99_ Star

Coffee tables

Tavolini, Beistelltische, tables basses

107_ Point

109_ Eolo + Basic

113_ I-modulART

115_ Brio

117_ Inside

Chairs

Sedie, Stühle, chaises

121_ Flex

123_ Chloe

125_ Iris

Mirrors

Specchiere, Spiegel, miroirs

129_ Tuttospecchio

131_ Domino

Shelves

Mensole, Borde, étagères

133_

Size

145_

Index

153_



Table _tailor

Il tavolo grande quanto ti pare. Tavolo rettangolare con piano fisso rovere "vissuto" basalto, a pagina successiva in ecomalta® grigio polvere, con basamento laccato opaco grigio antracite. Il tavolo è disponibile in 8 diverse dimensioni.

Il piano fisso del tavolo Tailor può essere realizzato anche su misura in lunghezza e larghezza.

(min.1800x900 max.3000x1050)

A table that is just the right size. Rectangular table with fixed "aged" basalto oak top and, on the next page, in grigio polvere ecomalta®, with matt grigio antracite lacquered support.

The table is available in 8 different sizes.

The fixed top of the Tailor table is also available custom-sized in length and width. (min.1800x900 max.3000x1050)

Der Tisch, so groß, wie Sie wollen. Rechteckiger Tisch mit fester Tischplatte in Eiche "im Antik-Look" basalto und auf der nächsten Seite in Ecomalta® grigio polvere, mit Grundgestell in Lack matt grigio antracite. Der Tisch ist in 8 verschiedenen Größen erhältlich. Die feste Tischplatte des Tisches Tailor kann in Länge und Breite auch nach Maß angefertigt werden.

(min.1800x900 max.3000x1050)

La table à la dimension souhaitée. Table rectangulaire avec plateau fixe en chêne "vécu" basalto et, page suivante, en ecomalta® grigio polvere, avec piètement laqué grigio antracite mat. La table existe en 8 dimensions au choix.

Le plateau fixe de la table Tailor peut également être réalisé sur mesure, en longueur et en largeur. (mini. 1800x900, maxi. 3000x1050)



È disponibile una coppia di prolunghe separate in laccato opaco alluminio, sono ancorabili al piano attraverso due staffe in metallo. Prolunghe e staffe trovano spazio in una apposita borsa con maniglie.
A pair of separate extensions are available in matt aluminium lacquer which can be fixed to the top by means of two metal brackets. The extensions and the brackets are stored in a specific bag with handles.



Der Tisch ist mit zwei separaten Verlängerungen in Lack matt aluminium lieferbar, die mit zwei Halterungen aus Metall an der Tischplatte befestigt werden. Die Verlängerungen und die Halterungen sind in einer bequemen Tasche mit Griffen untergebracht.
Il est possible de commander séparément une paire d'allonges laquées aluminium mat. Elles se fixent au plateau à l'aide de deux traverses en métal. Les allonges et les traverses peuvent être rangées dans un sac avec poignées prévu à cet effet.





Tavolo Taylor con sedia Flex in tessuto con gambe laccato opaco beige seta e sedia Chloe in Tecnopelle.
Taylor table with fabric upholstered Flex chair and matt beige seta lacquered legs, Chloe chair in Tecnopelle.
Tisch Taylor mit Stuhl Flex in Stoff mit Beinen in Lack matt beige seta. Stuhl Chloe in Tecnopelle.
Table Taylor avec chaise Flex en tissu avec pieds laqués beige seta mat. Ci-dessous, chaise Chloe en Tecnopelle.





Table _oplà

Tavolo rettangolare con piano allungabile e struttura in laccato opaco crema. Sedia Flex in tessuto con gambe laccato opaco crema.
Rectangular table with extending top and frame in matt crema lacquer. Fabric upholstered Flex chair with matt crema lacquered legs.
Rechteckiger Tisch mit ausziehbarer Platte und Struktur in Lack matt crema. Stuhl Flex in Stoff mit Beinen in Lack matt crema.
Table à rallonges rectangulaire avec plateau et structure laqués crema mat. Chaise Flex en tissu avec pieds laqués crema mat.

Dettaglio dell'allungamento del tavolo rettangolare con una allunga L.570. Per la versione L.1800 viene fornita di serie una allunga supplementare L.430 in finitura laccato opaco per una lunghezza totale di L.2800.
Close-up view of the extended rectangular table with the L.570 extension. An extra L.430 extension with a matt lacquered finish is standard supplied for the L.1800 table for a total length of L.2800.

Detailansicht der Verlängerung des rechteckigen Tisches mit einer Verlängerung B.570. Bei der Version L.1800 wird serienmäßig eine zusätzliche Verlängerung B.430 in Ausführung Lack matt für eine Gesamtlänge von 2800 geliefert.
Premier plan de la table rectangulaire allongée avec une allonge L.570. La version L.1800 est fournie, en standard, avec une allonge supplémentaire L.430 laquée mate permettant d'obtenir une longueur totale L. 2800 mm.





Table _star

Tavolo rettangolare con piano allungabile e gambe in rovere "vissuto" tabacco. Sedia Iris in tessuto.

Rectangular table with extending top and legs in "aged" tabacco oak. Fabric upholstered Iris chair.
Rechteckiger Tisch mit ausziehbarer Tischplatte und Beinen in Eiche "im Antik-Look" tabacco. Stuhl Iris in Stoff.
Table à rallonges rectangulaire avec plateau et pieds en chêne "vécu" tabacco. Chaise Iris en tissu.

Il tavolo Star con allunghe laterali aperte misura 2600mm. Dettaglio del tavolo con allunghe chiuse.
When its extensions are open, the Star table becomes 2600mm long. Close-up view of the table with closed extensions.

Der Tisch Star mit seitlichen Verlängerungen misst geöffnet 2600 mm. Detailsicht des Tisches mit geschlossenen Verlängerungen.

La table Star avec les deux allonges latérales mesure 2600 mm. Premier plan de la table sans les allonges.

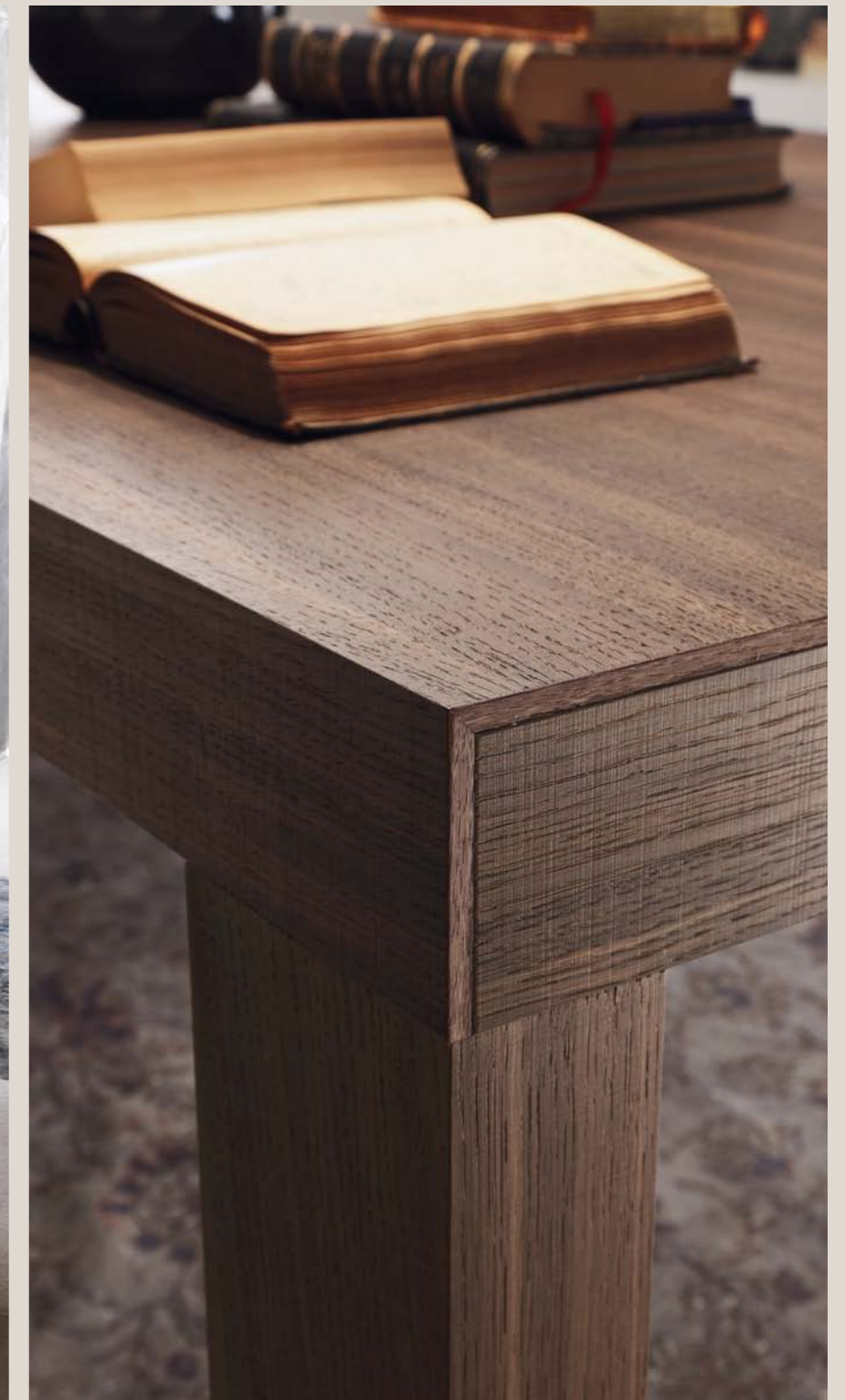



Sequenza di apertura delle allunghe laterali.
Sequence showing how to open the side extensions.
Schrittweises Öffnen der seitlichen Verlängerungen.
Différentes étapes de l'ouverture des allonges latérales.





Coffee tables

_point

Tavolini Point con struttura in metallo laccato opaco beige seta e marrone glacé. Il piano superiore oltre che in laccato opaco e lucido è disponibile anche con i 4 soggetti vintage. Disponibile anche con cassetto girevole.
Point coffee tables with matt beige seta and marrone glace lacquered metal frames. In addition to matt and gloss lacquer, the top is also available in the 4 vintage finishes. Also available with a swivel drawer.
Beistelltische Point mit Struktur aus Metall in Lack matt beige seta und marrone glacé. Die obere Platte ist neben der Version in Lack matt und Hochglanz auch mit den 4 Dekoren vintage lieferbar. Auch mit drehbarer Schublade erhältlich.
Tables basses Point avec structure en métal laqué beige seta et marrone glacé mat. Outre les coloris laqués mats ou brillants, on pourra également choisir, pour la finition du plateau supérieur, l'un des 4 dessins vintage. Disponible également avec tiroir pivotant.



ø504 H.440



ø504 H.440



_basic
_eolo



A pagina precedente: tavolini Eolo e Basic con struttura in metallo cromato e piano in ecomalta® beige argilla.
On the preceding page: Eolo and Basic coffee tables with chromed metal frames and beige argilla ecomalta® tops.

Auf der vorhergehenden Seite: Beistelltische Eolo und Basic mit Struktur aus verchromtem Metall und Platte in Ecomalta® beige argilla.

Page précédente: tables basses Eolo et Basic avec structure en métal chromé et plateau en ecomalta® beige argilla.

Sotto: tavolino Eolo con struttura in metallo laccato opaco nero frac e piani in pietra black slate.

Below: Eolo coffee table with matt nero frac lacquered metal frame and surfaces in black slate stone.

Unten: Beistelltisch Eolo mit Struktur aus Metall in Lack matt nero frac und Platten in Stein black slate.

Ci-dessous: Table basse Eolo avec structure en métal laqué nero frac mat et plateaux en pierre black slate.



620 620 H.390

Tavolino Basic con struttura in metallo cromato e piano in laccato opaco beige argilla.

Basic coffee table with chromed metal frame and matt beige argilla lacquered top.

Beistelltisch Basic mit Struktur aus verchromtem Metall und Platte in Lack matt beige argilla.

Table basse Basic avec structure en métal chromé et plateau laqué beige argilla mat.

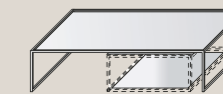

1285 620 H 440



_I - moduLART

Le basi I-moduLART rese bifacciali con un frontale fisso diventano tavolini modulari. Sotto, in laccato opaco beige cappuccino con bio-bruciatore a bioetanolo incassato su base con parafiamma in vetro temperato optional, non necessita di canna fumaria, la combustione del bioetanolo è pulita, senza fumi né emissione di esalazioni nocive.

The I-moduLART base units become double-sided thanks to a fixed front and are used here as modular coffee tables. Shown below, a base unit in matt beige cappuccino lacquer with the ecological bioethanol burner recessed into the top and an optional tempered glass fireguard. This burner doesn't require a flue because the combustion of bioethanol is clean and completely void of fumes or emissions of harmful exhalations.

Die Unterschränke I-moduLART werden durch den Einsatz einer zweiten festen Front zu modularen Beistelltischen. Unten in Lack matt beige cappuccino, der in den Unterschrank eingesetzte Bio-Brenner mit Bioethanol-Betrieb und Flammenschutz aus Sicherheitsglas als Option benötigt kein Rauchrohr, erzeugt weder Rauch noch schädliche Ausdünstungen und macht keinen Schmutz.

Les éléments bas I-moduLART transformés en élément double face grâce à une façade fixe deviennent des tables basses modulaires. Ci-dessous, élément bas en version laquée beige cappuccino mat avec bio-brûleur au bioéthanol encastré entouré d'un pare-feu optionnel en verre trempé. Ce dernier n'a pas besoin de conduit de fumée puisque la combustion du bioéthanol est propre et qu'elle ne produit ni fumées ni exhalations nocives.

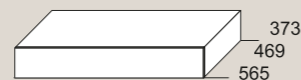

600/ 750/ 900/ 1200/ 1350/ 1500/ 1800/ 2100/ 2400/ H 192



_brío

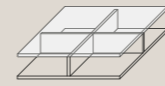

1000 1000 H.226

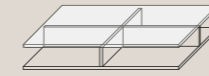

1200 620 H.226

Tavolini Brio in laccato opaco beige seta con piano in vetro trasparente.
Brio coffee tables in matt beige seta lacquer with a clear glass top.
Beistelltische Brio in Lack matt beige seta mit Platte aus transparentem Glas.
Tables basses Brio laquées beige seta mat avec plateau en verre transparent.





_inside



465 465 H.380





Chairs



_flex



440 545 H.880

Sedia Flex imbottita e sfoderabile, con seduta rivestita in tessuto e gambe laccato opaco beige seta, lo schienale è flessibile verso la parte posteriore per un migliore comfort. Sotto: varianti con gambe cromate ed in finitura alluminio naturale.

Padded Flex chair with removable cover, fabric upholstered seat, matt beige seta lacquered legs and a flexible backrest that bends backwards for greater comfort. Below: versions with chromed and natural aluminium finish legs.

Gepolsterter und abziehbarer Stuhl Flex mit Sitzfläche mit Stoffbezug und Beinen in Lack matt beige seta, die Rückenlehne ist für einen besseren Sitzkomfort im oberen Teil flexibel. Unten: Varianten mit verchromten Beinen und in Ausführung Aluminium Natur.

Chaise Flex rembourrée et déhoussable, avec assise revêtue en tissu et pieds laqués beige seta mat. Le dossier s'incline vers l'arrière pour un meilleur confort. Ci-dessous: variantes avec pieds chromés et finition aluminium naturel.



_chloe



445 550 H.880

Sedia Chloe con seduta e gambe in pelle (non sfoderabile); lo schienale è flessibile e avvolgente in senso orizzontale per una particolare sensazione di comfort.

Chloe chair with seat and legs upholstered with non-removable leather; the backrest is flexible and offers great horizontal support for an exceptionally comfortable experience.

Stuhl Chloe mit Sitzfläche und Beinen in Leder (nicht abziehbar); die Rückenlehne ist flexibel und nach oben hin leicht gewölbt, um besonderen Sitzkomfort zu schenken.

Chaise Chloe avec assise et pieds en cuir (non déhoussable); le dossier est flexible et enveloppant dans le sens horizontal pour une sensation de confort particulière.





_iris

Sedia Iris con gonna imbottita e sfoderabile, con seduta rivestita in tessuto, lo schienale è flessibile verso la parte posteriore per un migliore comfort.
Padded Iris chair with removable cover and skirt, fabric upholstered seat and a flexible backrest that bends backwards for greater comfort.
Gepolsterter und abziehbarer Stuhl Iris mit Husse, Sitzfläche mit Stoffbezug, die Rückenlehne ist für einen besseren Sitzkomfort im oberen Teil flexibel.
Chaise Iris avec jupe longue, rembourrée et déhoussable, avec assise revêtue en tissu. Le dossier s'incline vers l'arrière pour un meilleur confort.



440 545 H.880





Mirrors

_tuttospecchio

Specchiera Tuttospecchio
con piedini cromati.
Tuttospecchio mirror with
chromed feet.
Spiegel Tuttospecchio mit
verchromten Füßen.
Miroir Tuttospecchio avec
pieds chromés.

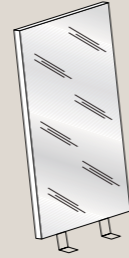

600 80/195 H 2220





_domino

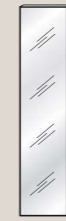

420 45 H.1860



650 45 H.1860



900 45 H.420



900 45 H.900

Composizione di specchiere Domino con profilo in alluminio finitura brill e retroilluminazione a led optional.
 Composition with Domino mirrors and brill finish aluminium frames with optional led backlighting.
 Zusammenstellung mit Spiegel Domino mit Aluminiumprofil Ausführung brill und LED-Hintergrundbeleuchtung als Option.
 Composition de miroirs Domino avec profils en aluminium finition brill et rétro-éclairage à led optionnel.





Shelves



Elementi libreria I-modulART in rovere "vissuto" basalto e laccato opaco beige seta e arancio mango.
I-modulART bookcase elements in "aged" basalto oak and matt beige seta and arancio mango lacquer.
Bücherregale I-modulART in Eiche "im Antik-Look" basalto und Lack matt beige seta und arancio mango.
Éléments bibliothèque I-modulART en chêne "vécú" basalto et laqués beige seta et arancio mango mat.





La materia che rigenera le emozioni. Mensole inclinART laccato opaco grigio antracite ed ecomalta® grigio polvere.
The materials that regenerate emotions. Matt grigio antracite and grigio polvere ecomalta® InclinART shelves.
Eine Materie, die Emotionen weckt. Borde inclinART in Lack matt grigio antracite und Ecomalta® grigio polvere.
La matière qui régénère les émotions. Étagères inclinART laquées grigio antracite mat et en ecomalta® grigio polvere.



Mensole Sp.50 I-modulART laccato opaco beige argilla con illuminazione a led inferiore e superiore. A lato le mensole sono in ecomalta® beige argilla con pannelli specchio bronzo. Matt beige argilla lacquered, 50mm thick, I-modulART shelves with led lighting above and below. To the side, the shelves are in beige argilla ecomalta® with bronze mirror panels. Borde St. 50 I-modulART in Lack matt beige argilla mit oberer und unterer LED-Beleuchtung. Seitlich: Borde in Ecomalta® beige argilla mit Spiegelpaneel bronzo. Étagères Sp.50 I-modulART laquées beige argilla mat avec éclairage à led dans le bas et dans le haut. Ci-contre, les étagères en ecomalta® beige argilla sont fixées à des panneaux miroir bronze.





Mensole e panca I-modulART H.96 in ecomalta® beige argilla con pannelli specchio bronzo. La panca H.96 diventa un pratico scrittoio.
I-modulART shelves and bench H.96 in beige argilla ecomalta® with bronze mirror panels. The bench H.96 becomes a practical desk.
Borde und Bank I-modulART H.96 in Ecomalta® beige argilla mit Spiegelpaneel bronzo. Die Bank H.96 wird zu einem praktischen Schreibtisch.
Étagères et banc I-modulART H.96 en ecomalta® beige argilla fixés à des panneaux miroir bronze. Le banc H.96 se transforme en un pratique plan de bureau.



Elementi a giorno I-modulART in vetro con schienale in laccato opaco marrone glacé.
A lato mensole I-modulART con piano in metallo finitura alluminio e schienali specchio
con compensazione fino a pavimento.
Glass I-modulART open units with back panel in matt marrone glace lacquer.
Opposite, I-modulART shelves with aluminium finish metal surfaces and mirror back
panels with a floor-standing filler panel.
Offene Elemente I-modulART aus Glas mit Rückwand in Lack matt marrone glacé.
Seitlich: Borde I-modulART aus Metall in Aluminiumausführung und Spiegelrückwand
mit Ausgleichselement bis zum Fußboden.
Éléments ouverts I-modulART en verre avec fond laqué marrone glacé mat.
Ci-contre, étagères I-modulART avec plan en métal finition aluminium fixés à des
panneaux miroir posant au sol.





size

Caratteristiche dimensionali

Dimensional features

Größenmerkmale

Caractéristiques des dimensions

Madie con 1 anta battente per vano **H.584**
 Sideboards with 1 swing door for each compartment **H.584**
 Sideboards mit 1 Drehtür pro Abteil **H.584**
 Buffets avec 1 porte battante par compartiment **H.584**

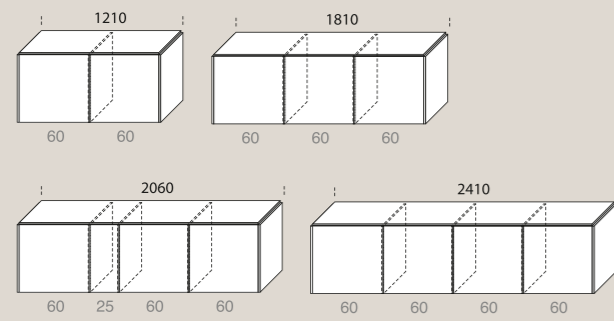

Madie con ante battenti, cassetti e anta ribalta **H.584**
 Sideboards with swing doors, drawers and bottom-hung flap door **H.584**
 Sideboards mit Drehtüren, Schubladen und Klapptür **H.584**
 Buffets avec portes battantes, tiroirs et porte abattante **H.584**

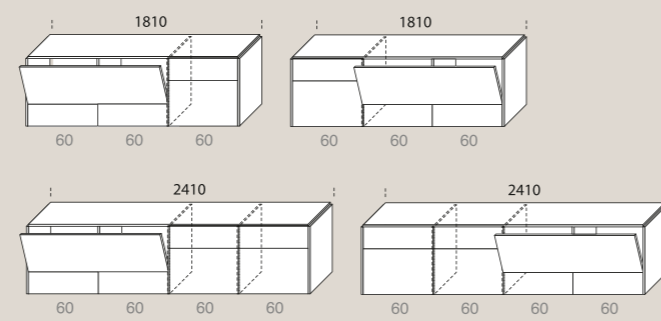

Madie con 1 anta battente per vano **H.776**
 Sideboards with 1 swing door for each compartment **H.776**
 Sideboards mit 1 Drehtür pro Abteil **H.776**
 Buffets avec 1 porte battante par compartiment **H.776**

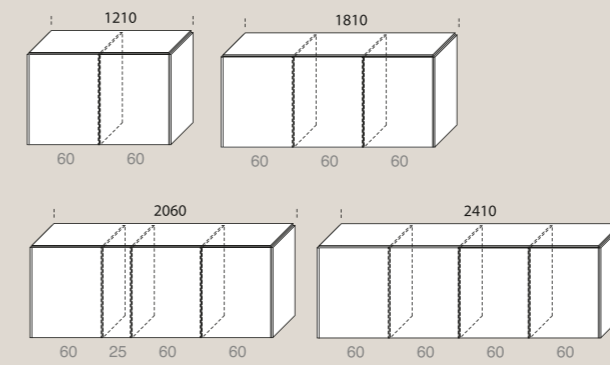

Madie con ante battenti e cassetti **H.776**
 Sideboards with swing doors and drawers **H.776**
 Sideboards mit Drehtüren und Schubladen **H.776**
 Buffets avec portes battantes et tiroirs **H.776**

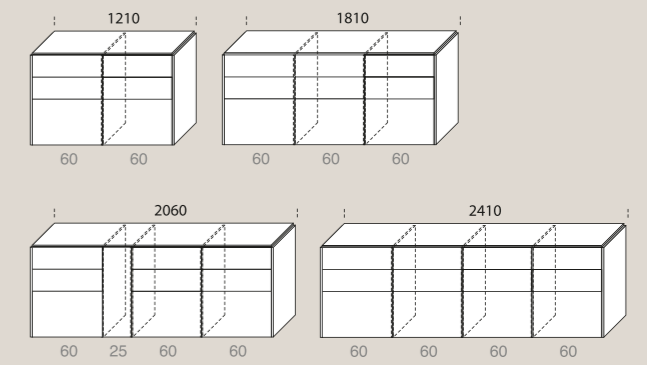

Madie con 2 ante battenti asimmetriche per vano **H.584**
 Sideboards with 2 unsymmetrical swing doors for each compartment **H.584**
 Sideboards mit 2 asymmetrischen Drehtüren pro Abteil **H.584**
 Buffets avec 2 portes battantes asymétriques par compartiment **H.584**

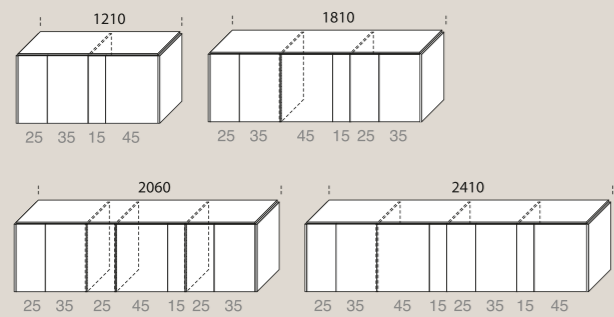

Madie con ante battenti e cassetti **H.584**
 Sideboards with swing doors and drawers **H.584**
 Sideboards mit Drehtüren und Schubladen **H.584**
 Buffets avec portes battantes et tiroirs **H.584**

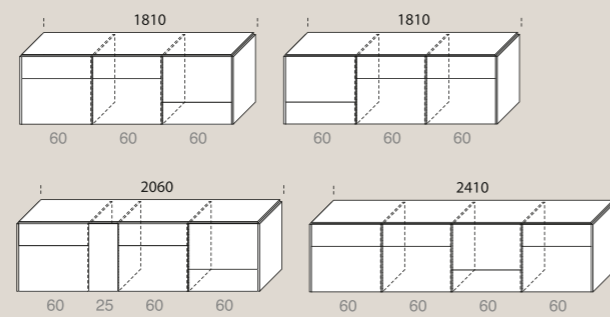

Madie con ante battenti e cassetti **H.776**
 Sideboards with swing doors and drawers **H.776**
 Sideboards mit Drehtüren und Schubladen **H.776**
 Buffets avec portes battantes et tiroirs **H.776**

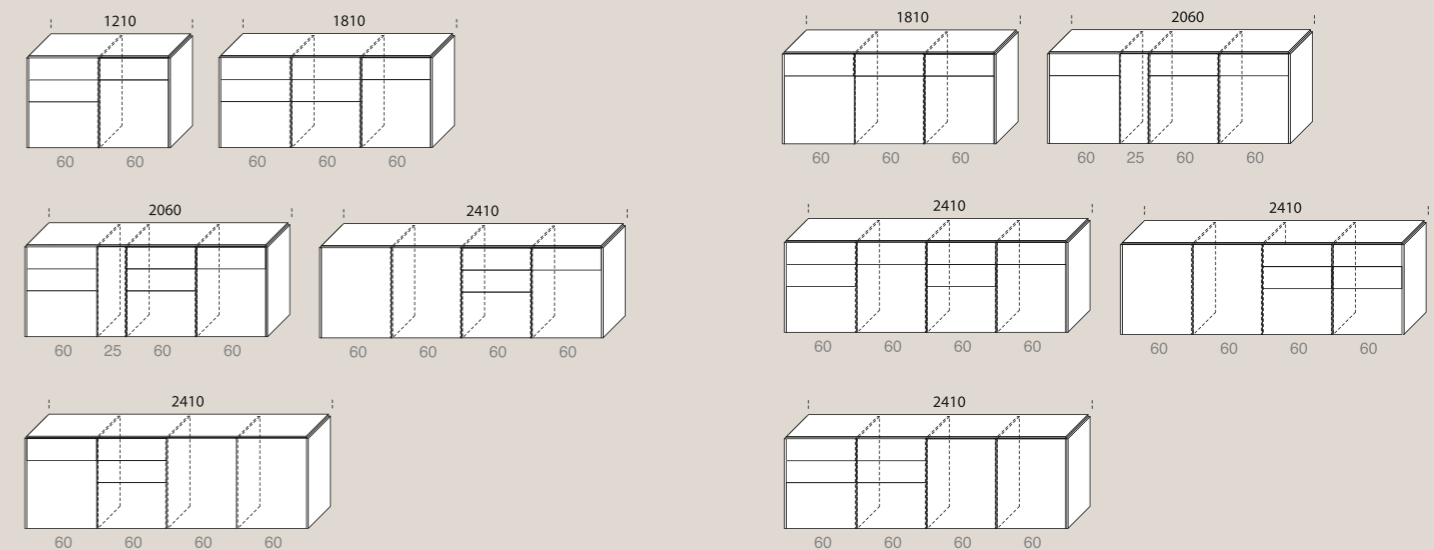

Caratteristiche dimensionali

Dimensional features

Größenmerkmale

Caractéristiques des dimensions

Madie con 1 anta battente per vano **H.1160**
 Sideboards with 1 swing door for each compartment **H.1160**
 Sideboards mit 1 Drehtür pro Abteil **H.1160**
 Buffets avec 1 porte battante par compartiment **H.1160**

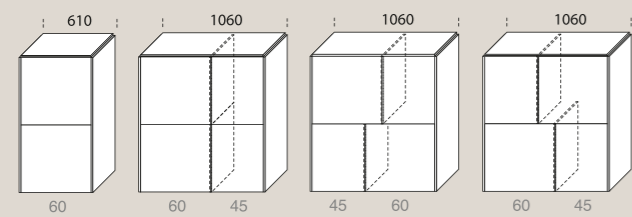

Madie con 2 ante battenti asimmetriche per vano **H.1160**
 Sideboards with 2 unsymmetrical swing doors for each compartment **H.1160**
 Sideboards mit 2 asymmetrischen Drehtüren pro Abteil **H.1160**
 Buffets avec 2 portes battantes asymétriques par compartiment **H.1160**

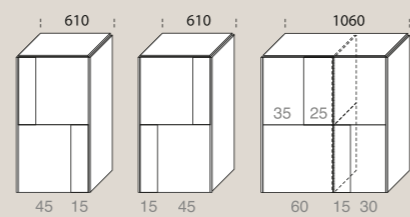

Madie con 1 anta battente per vano **H.584 inclinART**
 Sideboards with 1 swing door for each compartment **H.584 inclinART**
 Sideboards mit 1 Drehtür pro Abteil **H.584 inclinART**
 Buffets avec 1 porte battante par compartiment **H.584 inclinART**

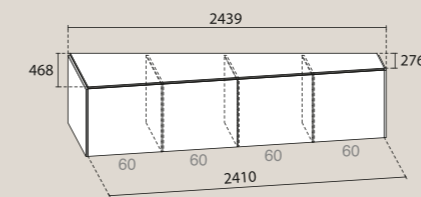
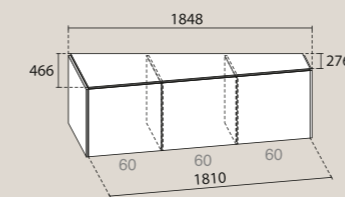
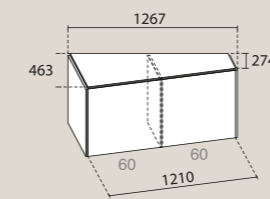

Madie con 2 ante battenti asimmetriche per vano **H.584 inclinART**
 Sideboards with 2 unsymmetrical swing doors for each compartment **H.584 inclinART**
 Sideboards mit 2 asymmetrischen Drehtüren pro Abteil **H.584 inclinART**
 Buffets avec 2 portes battantes asymétriques par compartiment **H.584 inclinART**

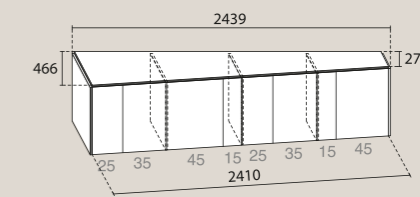
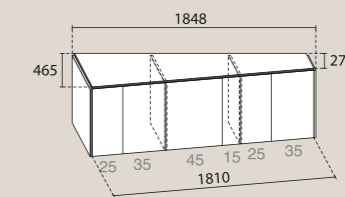
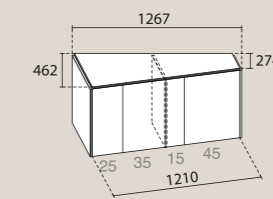

Madie con ante battenti e cassetti **H.1160**
 Sideboards with swing doors and drawers **H.1160**
 Sideboards mit Drehtüren und Schubladen **H.1160**
 Buffets avec portes battantes et tiroirs **H.1160**

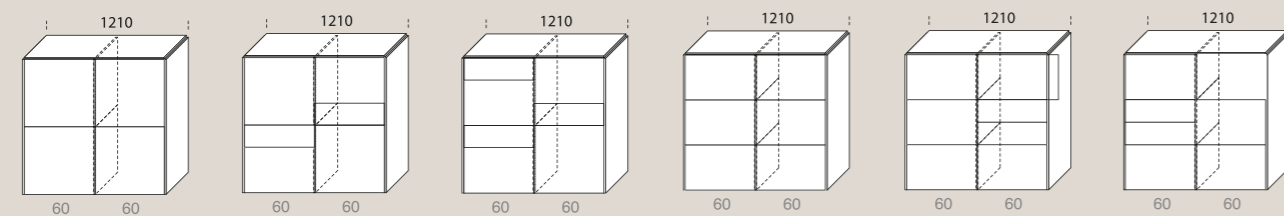

Madie con 2 ante battenti asimmetriche per vano **H.1736**
 Sideboards with 2 unsymmetrical swing doors for each compartment **H.1736**
 Sideboards mit 2 asymmetrischen Drehtüren pro Abteil **H.1736**
 Buffets avec 2 portes battantes asymétriques par compartiment **H.1736**

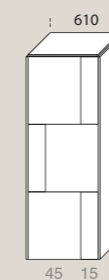

Madie con 1 anta battente per vano **H.1736**
 Sideboards with 1 swing door for each compartment **H.1736**
 Sideboards mit 1 Drehtür pro Abteil **H.1736**
 Buffets avec 1 porte battante par compartiment **H.1736**

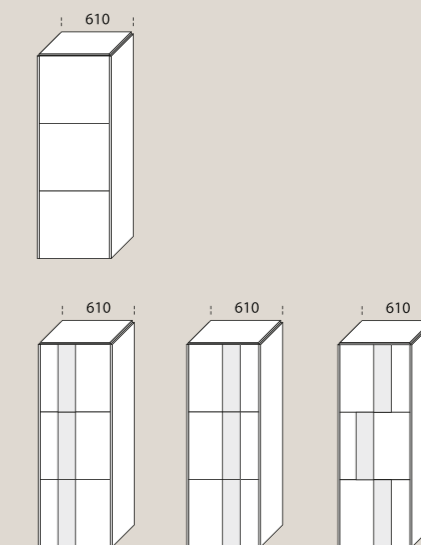

Madie con ante battenti SP.20 con fascia in vetro trasparente **H.1160**
 Sideboards with 20mm thick swing doors and transparent glass strip **H.1160**
 Sideboards mit Drehtüren ST. 20 mit Einsatz aus transparentem Glas **H.1160**
 Buffets avec portes battantes SP.20 avec bandeau en verre transparent **H.1160**

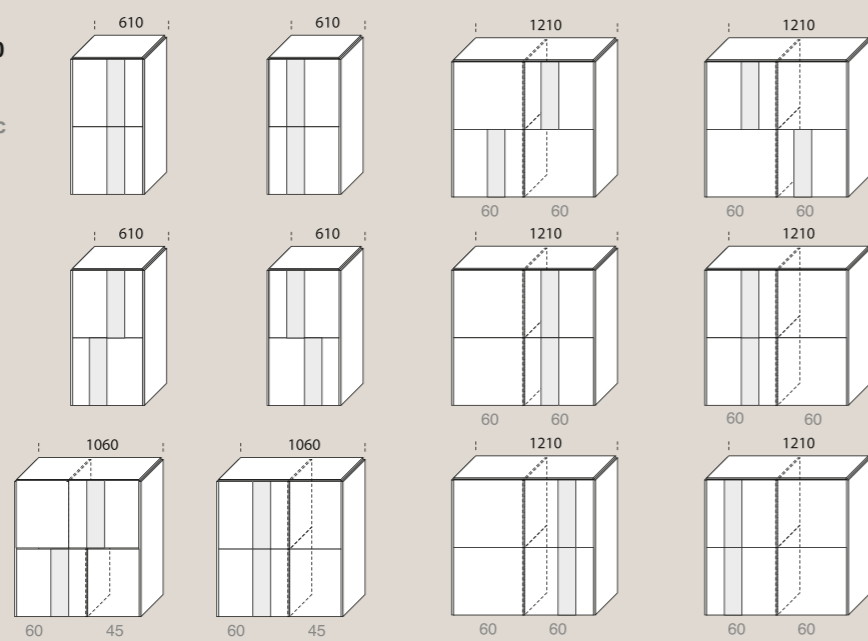

Caratteristiche dimensionali
Dimensional features
Größenmerkmale
Caractéristiques des dimensions

Domino mirror

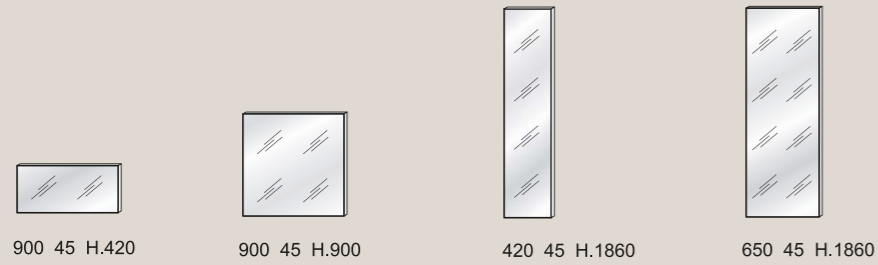

Tuttospecchio mirror

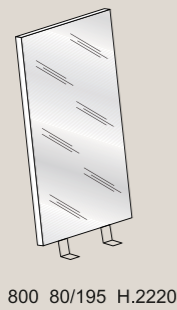

Oplà Table

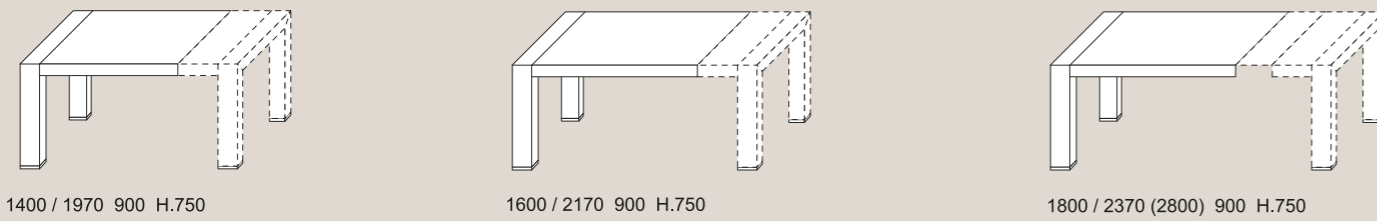

Tailor table

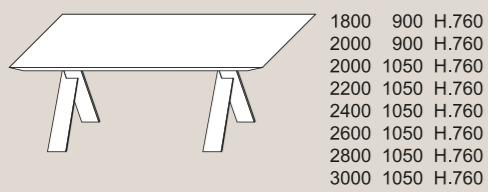

Star Table

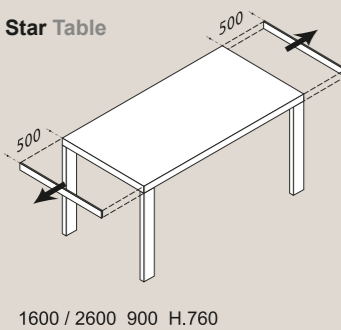

Basic coffee table

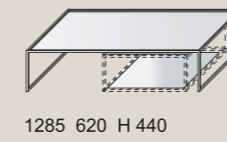

Eolo coffee table

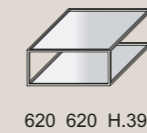

Brio coffee table



Flex chair



Iris chair

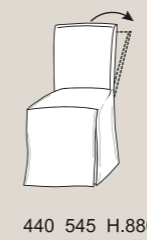

Point coffee table



I-modulART coffee table

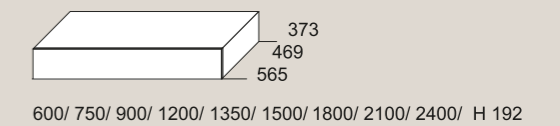

Inside coffee table

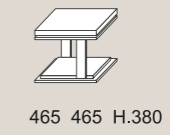

Chloe chair





index

_InclinART H.584

pag. 37 _

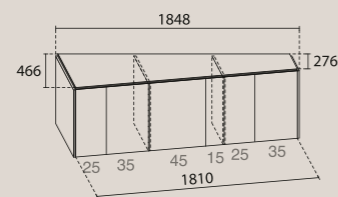

pag. 41 _

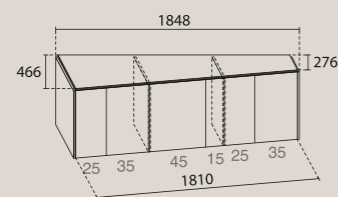

pag. 43 _

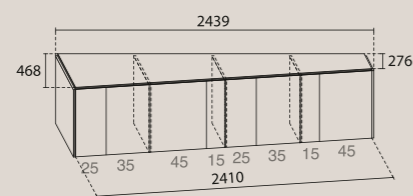

_Sideboard inclinART

Per le versioni I-modularART consultare il listino prezzi.
For the I-modularART versions please consult the relevant price list.
Für die Versionen I-modularART verweisen wir auf die diesbezügliche Preisliste.
Pour les versions I-modularART, consulter le tarif correspondant.

#300

pag. 45_
51_

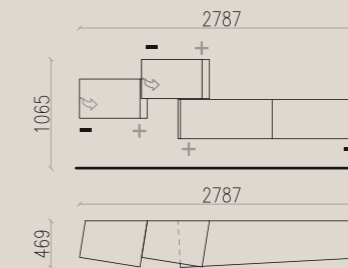

#301

pag. 53 _

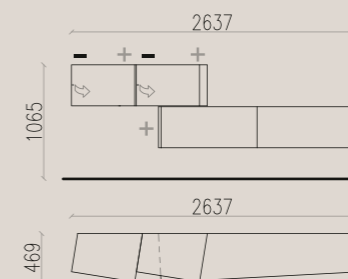

#295

pag. 35 _

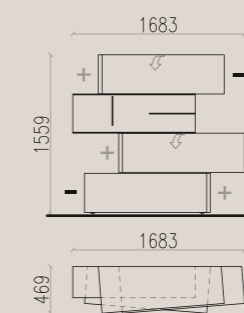

_H.584

pag. 21 _

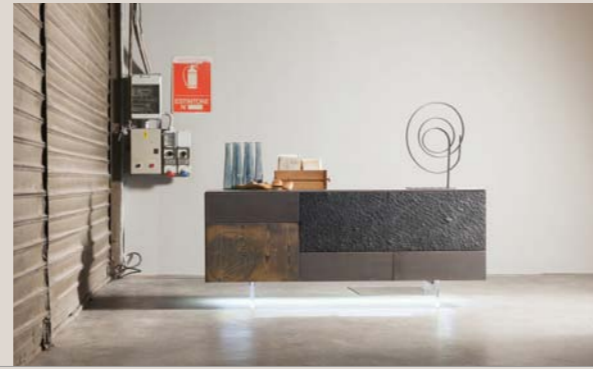
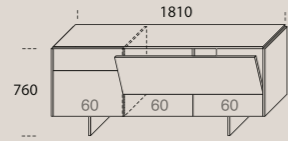

pag. 17 _

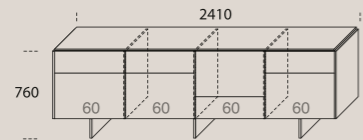

pag. 23 _

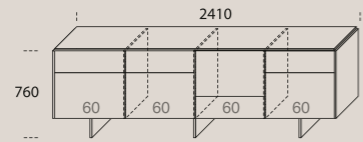

pag. 29 _

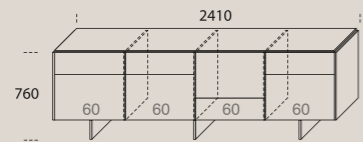

pag. 19 _

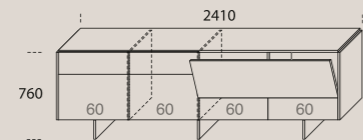

_H.776

pag.61 _

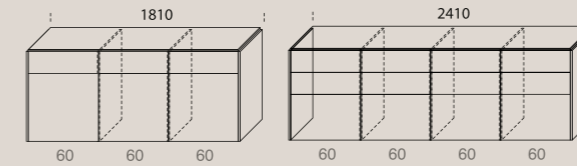

pag. 65 _

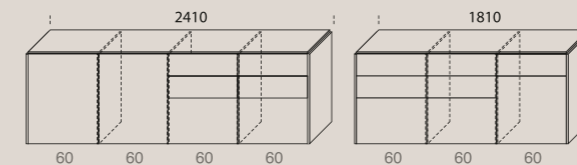

_Mood

pag. 69 _

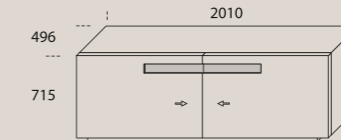

_H.1160

pag. 79 _

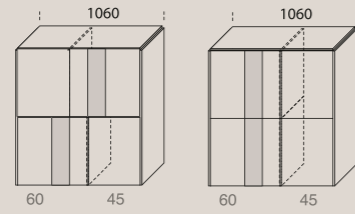

pag. 75 _

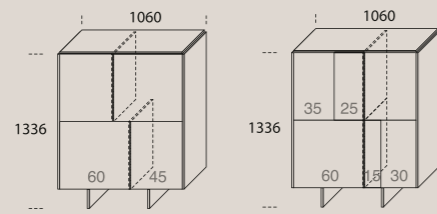

pag. 76 _

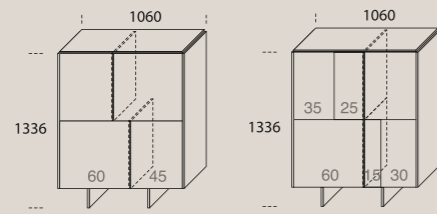

Tables

_tailor

pag. 87 _



_oplà

pag. 95 _



_H.1736 _H.1160

pag. 80 _

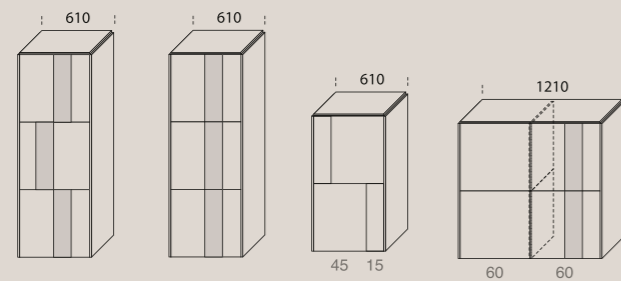

_star

pag. 99 _



Chairs

_flex

pag. 121 _



_chloe

pag. 123 _

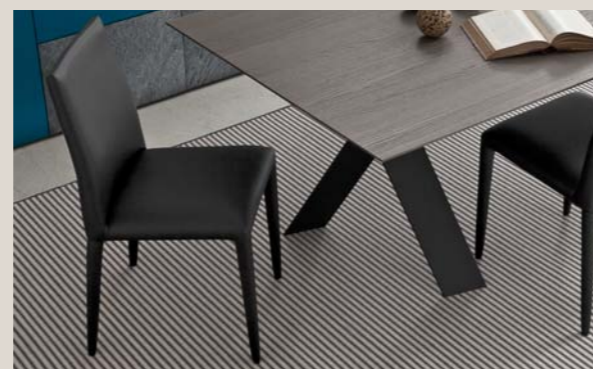

_iris

pag. 125 _



Mirrors

_tuttospecchio

pag. 129 _



_domino

pag. 131 _



Coffee tables

_point

pag. 107 _



_eolo _basic

pag. 109 _



_I-modulART

pag. 113 _



_brio

pag. 115 _



_inside

pag. 117 _



Shelves

pag. 135 _



pag.137 _



pag. 139 _



pag. 141 _



pag. 142 _



pag. 143 _



PRESOTTO
ITALIA

giugno_2013

Marketing:
Presotto Italia

Art Direction:
Pierangelo Sciuto

Graphic Designer:
Fulvio Serasin

Photo:
F2 fotografia
Contratti & co

Styling:
Laura Comiotto

Color separation:
gfp.it

Print:
gfp.it

printed in Italy

Azienda con sistema di gestione
ambientale conforme al Regolamento
Europeo EMAS

A company with an environmental
management system complying with the
EMAS European Regulations.



Azienda con certificazione del sistema
di gestione ambientale e della salute
e sicurezza sui luoghi di lavoro.

Company using a certified environment
and health and safety on the workplace
management system.



Copyright © 2013 Presotto Italia

tutti i diritti sono riservati.

è vietata la riproduzione
sotto forma di stampa, fotocopia,
microfilm, o qualsiasi altro sistema,
senza il permesso scritto
della società autrice.

all rights reserved.

no part of this catalogue
may be reproduced in any form
by print, photocopy, microfilm,
recording or any other means
without the prior written
permission of the publishers.

presotto industrie mobili spa via puja, 7 frazione maron 33070 brugnera
(pordenone) italy t +39 0434 618111 f +39 0434 613558 www.presottoitalia.it